



# CreatBot 3D Printer

## User manual

English V7.3

# CONTENTS

Notice .....	3	Mouse Operation .....	22
Machine Diagram		Model Rotate/Scale .....	22
Front .....	4	Model Mirror .....	23
Printer Head .....	5	View Mode .....	24
Hardware Installation		Right Click on Model .....	25
Unpacking .....	6	Toolpath Structure .....	25
Printer Operation		Basic Setting .....	26
Leveling Platform .....	7	Advanced Setting .....	27
Paving Crepe Paper .....	7	Expert Setting .....	28
Load Filament .....	8	Skirt/Brim/Raft .....	29
Unload Filament .....	9	Plugins .....	29
Main menu .....	10	Start/End Gcode .....	30
Status page .....	11	Dual Head Printing .....	30
Detail page .....	12	Align Dual Head Horizontal ..	31
Printing page .....	13	Add Multi Type Printer .....	32
Axis operation .....	14	Print Different Filament .....	32
Filament menu .....	15	Using skills	
SD Card/U-disk .....	16	Change Fuse .....	33
Setting menu .....	17	Routine Maintenance.....	33
Info. menu .....	18	Installation section .....	34
Software Operation		Software .....	35
CreatWare Setup .....	19	Remove prints .....	35
Quick Print UI .....	20	Hardware Troubleshoot .....	36
Print Your First Model .....	20	Printing Troubleshoot .....	37
Full Setting UI .....	21	Specifications .....	38

## Icon conventions



Tip icon to remind users to have a good method or technique.



Note icon, to remind the user must be given adequate attention.



Prohibition icons, prevents users from unauthorized operation.

# Notice

## Read First

Thank you for choosing CreatBot 3D printer!

This manual contains important information about the installation, use, maintenance and common problems of CreatBot 3D printer. Please read this manual carefully before using 3D printer. All losses caused by the breach of the notes and the operation process of the operation process will be borne by the user. Please use the filament provided by CreatBot, or high quality filament by third manufacturers. Due to the use of third party inferior material caused by the failure of the printer, the loss will be borne by the user.

Software running environment, 2G or above processors, at least 1G memory, compatible with Windows, MAC, or Linux, please use memory as much as possible.

I wish you have fun with CreatBot 3D printer!

## Danger Warning



The nozzle's temperature will reach 300 degrees, don't touch.



The platform's temperature will reach 120 degrees, don't touch.



Please make sure that the printer connected to the ground.



Do not attempt to open the case, be careful of electric shock.

## Working Environment



The 3D printer can work in the indoor environment of 5 °C to 30 °C.



Long-term not use of the printer, be sure to dust, moisture.



Long-term not use of the filament, please be sealed to prevent deterioration.

# Machine Diagram

## Front and Back



- 1、LCD Touch screen
- 2、Usb input
- 3、Indicator light
- 4、tuyere temperature

- 5、tuyere temperature adjustment button
- 6、emergency stop button
- 7、Power switch

# Machine Diagram

## Indicator light

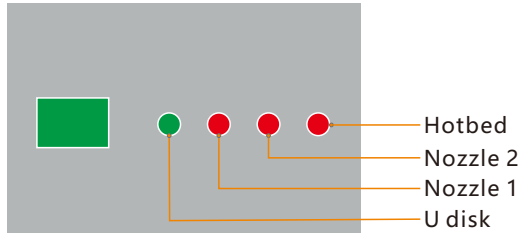

## Printer Head

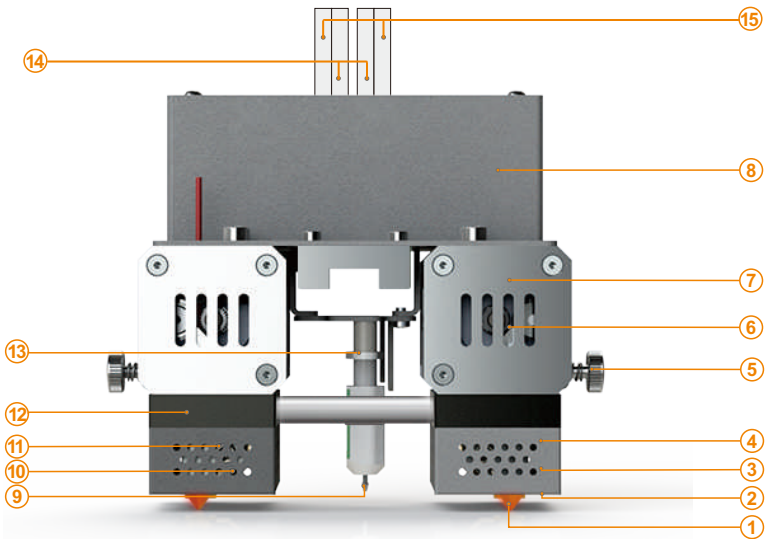

- 1、 Nozzle
- 2、 cold/hot tuyere
- 3、 protection cover
- 4、 Heatbreak+ Heating tube
- 5、 Arm spring + nut
- 6、 Extrusion motor

- 7、 extruder box
- 8、 head circuit box
- 9、 Bltouch
- 10、 temperature controller
- 11、 Heating tube

- 12、 heat sink
- 13、 water cooling pipe
- 14、 water cooling pipe
- 15、 air cooling

## 耗材仓配置

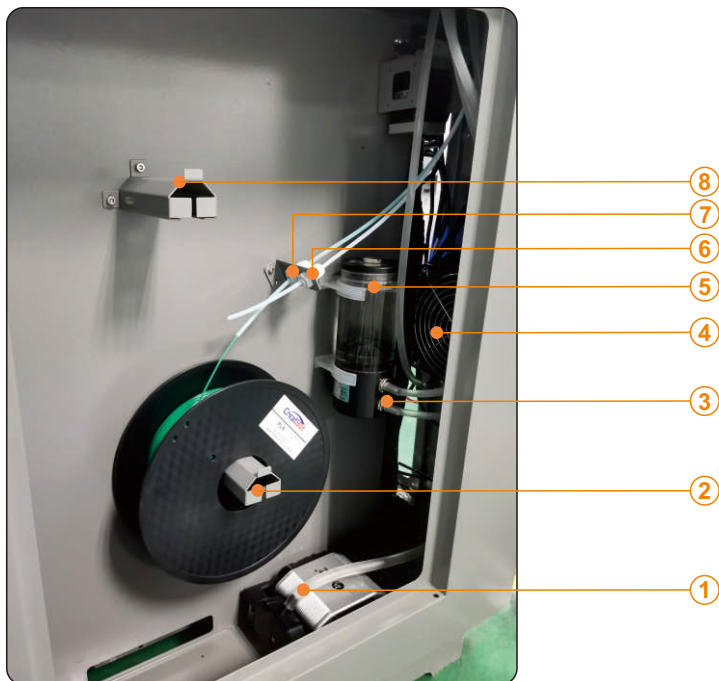

- 1、blower
- 2、 filament rack 1
- 3、 water-cooled tube
- 4、 Water tank + cooling fan

- 5、 water pump
- 6、 feed pipe
- 7、 feed pipe2
- 8、 filament rack2

# Hardware Installation

## Unpacking



Turn on printer

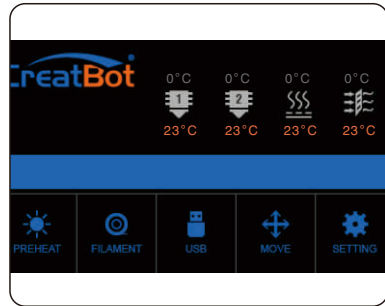

Preheat head

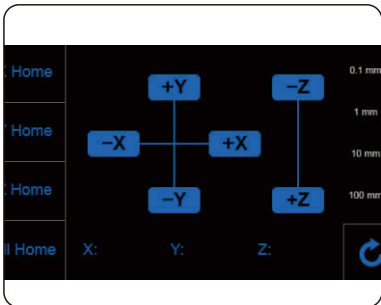

Move axis



Take out filament

1. Ensure the packing is not broken.
2. Need two people at the same time.
3. Lift it out by grasping the frame, not the belt or rails.
4. Turn on the printer, enter "Move axis" menu, select "All home", the bracket will rise, now you can takeout filament.

# Printer Operation

## Leveling Platform

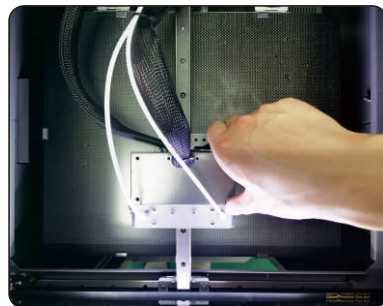

### I Leveling platform manually

1. Turn on the printer.
2. On touch screen, press "Move axis" -> "All home"
3. Then "-Z" -> 100mm.
4. Move the extruder by hand to 4 corners of bed. Tighten or loosen 4 black nuts below the bed to make sure the distance between nozzle and bed is 0.2mm around. (Approximately the thickness of one piece of name card)
5. All home secondly.
6. "-Z"-->100mm secondly. Focus on the distance between the nozzle and bed. It needs to be 0.1mm around. If the distance too far, increase Servo Z offset value (+0.1mm each time). If too close or touch the bed, decrease Servo Z offset value. (-0.1mm each time).

### II Auto leveling

1: Enter "Setting"->"Auto leveling" ->"Probe". Machine will start to detect 25 points.

**Note:** Servo Z offset means vertical height between nozzle and detector when probe needle outstretch. It is a fixed value if you don't change hotend or detector.

Contact us for videos. Or Youtube enter keywords **CreafBot F430 leveling bed**



# Printer Operation

## Load Filament

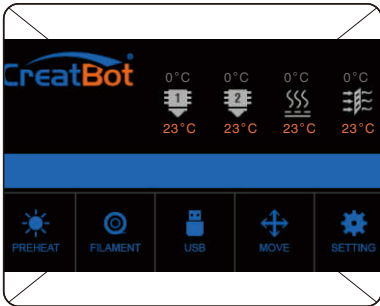

Preheat head



Load filament

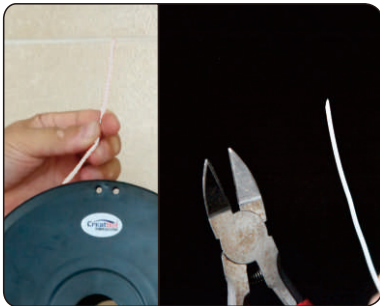

Sharpen and straighten filament head

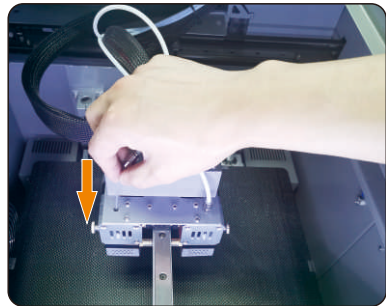

Get filament through

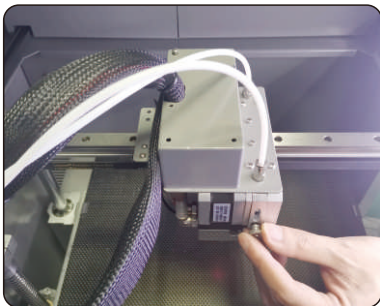

Tighten pressure nut

- 1.Preheat nozzle first.
- 2.Twist the printed parts,and load filament roll. Get filament through guide tube until extruder. Sharpen and straighten filament head,and check filament if they wind themself.
3. Loosen pressure nut (no need to remove),put filament into extruder hold and press filament to nozzle,until filament are extruded well. (Using skills see page 34)
- 4.Tighten pressure nut. (twist pressure nut 8~12 times after nut touch spring. Neither too loose,nor too tight)



*Notice: Pressed filament too tight or too loose will affect normal wire feeding.*

## Printer Operation

### Unload Filament

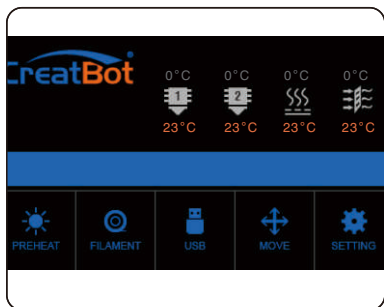

Preheat head



Unload filament menu



Pull out filament

1. Enter "Filament" menu -> "Unload filament", and select the head you want unload.
2. Wait for the nozzle heated to a suitable temperature.
3. After reaching temperature, feeder will send a certain number of filament, and then automatically withdraw filament.
4. To manually unload filament, same as above mentioned.

 **Warning:** It is strictly prohibited without heating nozzle.

 **Tip:** If filament stuck in the guide tube, continue printing several lengths and retry.

# Printer Operation

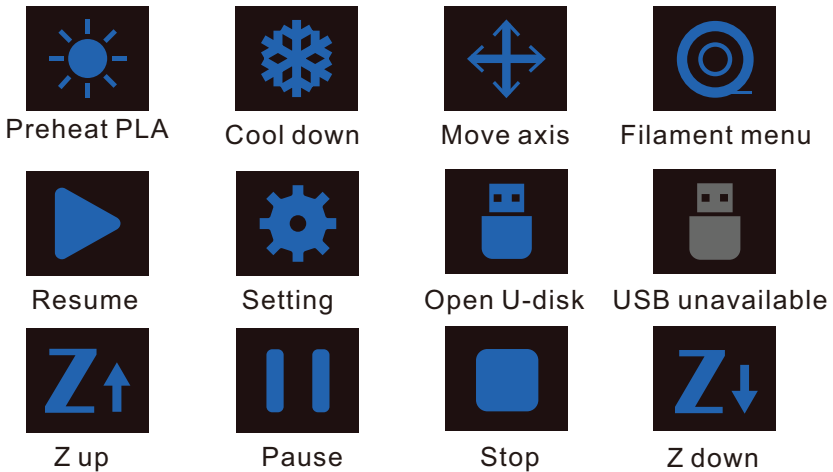
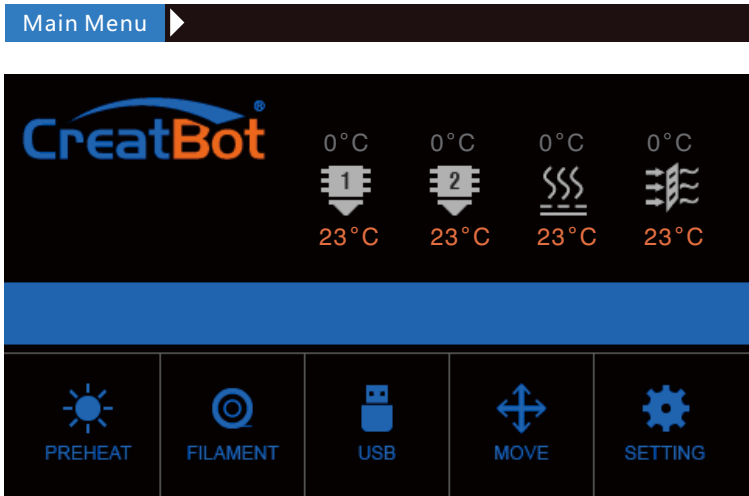

# Printer Operation

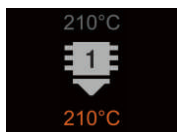
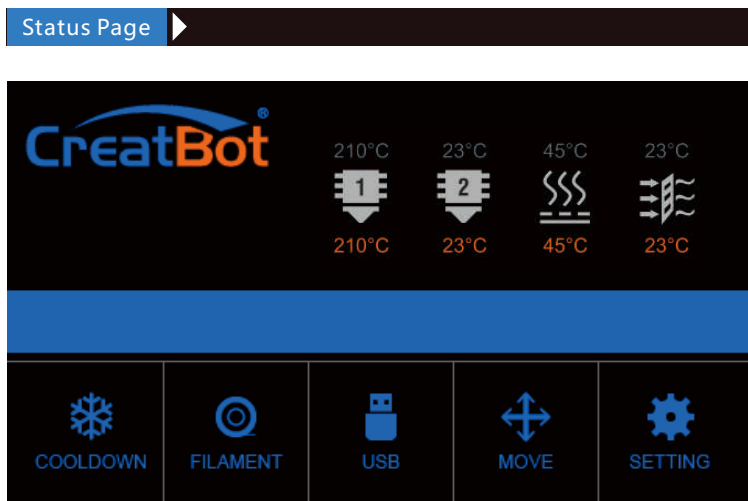

Touch and set up the temp of the nozzle.  
**210°C** Preset nozzle temperature  
**210°C** Current nozzle temperature



Touch and set up the temp of the nozzle.  
**45°C** Preset nozzle temperature  
**40°C** Current nozzle temperature

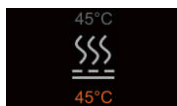

Touch and set up the temp of the hotbed.  
**210°C** Preset platform temperature  
**200°C** Current platform temperature



Touch and set up the temp of the hot wind.  
**45°C** Preset hot air temperature  
**40°C** Current hot air temperature

# Printer Operation

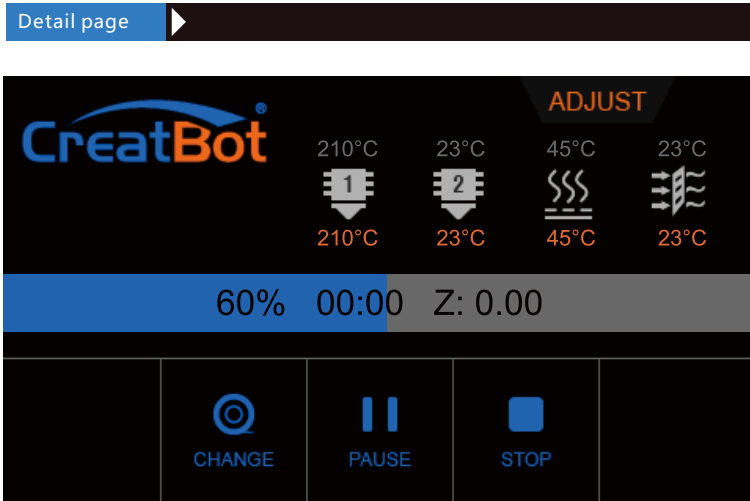

# Printer Operation

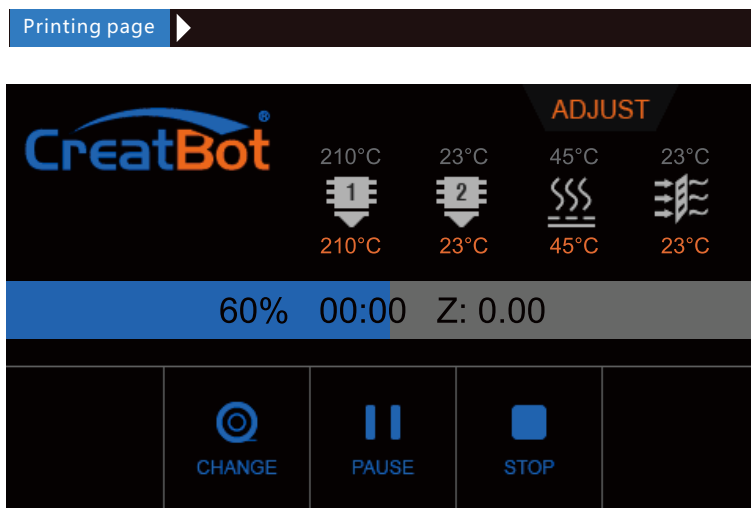

60.00% 00:00 Z:0.00 Current printing progress



Pause and Change filament.



Cancel print



Pause print



*The display will get darken when no operation in ten seconds and can be waken by clicking anywhere on the screen.*

*When the display shows the default print page, click anywhere except the buttons to turn back to the print details page.*

# Printer Operation

Axis operation ▶

X Home				0.1 mm
Y Home				1 mm
Z Home				10 mm
All Home				100 mm
	X:	Y:	Z:	

**1mm**

Minimum units

**X Home**

Move X to home

**±X/Y**

Move X/Y axis

**Y Home**

Move Y to home

**-Z**

Z up

**Z Home**

Move Z to home

**+Z**

Z down

**All Home**

All axis to home





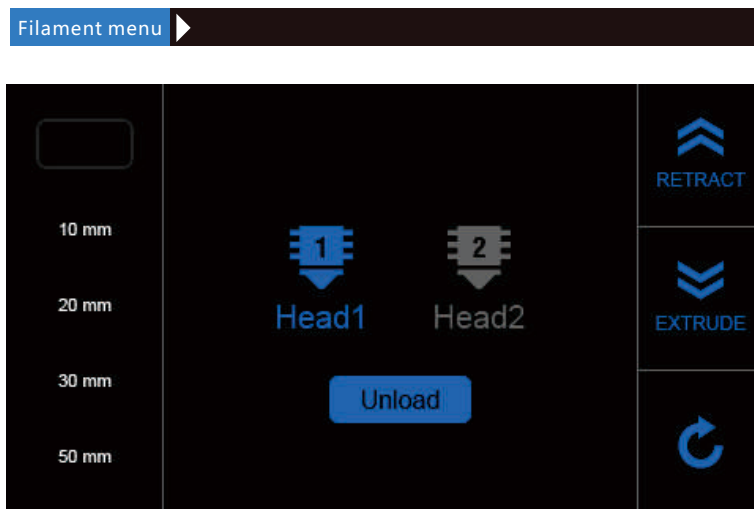

**X:00.00**  
**Y:00.00**  
**Z:00.00**

X,Y,Z current position of hotend.

Back

# Printer Operation



10	Click and enter a value	 Head 1	#1 extruder
10 mm 20 mm	Adjust value when extrude/retract filament	 Head 2	#2 extruder (unavailable)
		 Unload	Retract filament
	Extrude filament		Retract filament
			Back



*When you want to remove the filament, you need first to heat the extruder.*



# Printer Operation



file1.gcode Click and choose a  
file2.gcode file to print



Last page



Next page



Superior menu



Back



# Printer Operation

Setting menu ▶



X step: 106.6667    Z step: 106.6667    X/Y/Z and extruder motor setting (range:5-9999)  
Y step: 1600.0000    E step: 128.0000



# Printer Operation

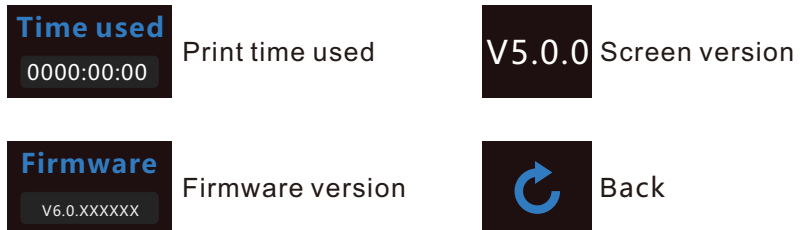

# Software Operation

## CreatWare Setup

Download CreatWare installation package from the CD-ROM or [www.CreatBot.com](http://www.CreatBot.com), follow the prompts to install the software, try using the default installation path as well.

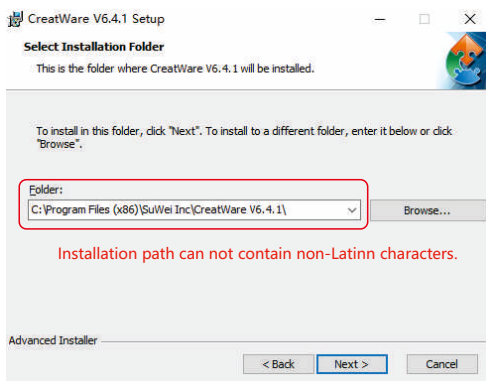
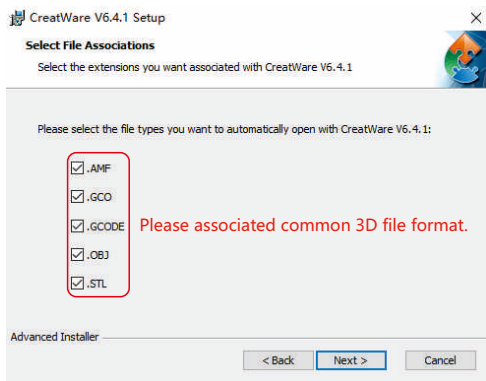

Please associated common 3D file format.

When there is a driver digital signature, please choose to agree. When finished the driver folder will locate at installation directory.

The software will select the correct language according to your OS, please select the right machine type and number of nozzles and ignore the other option and guide.

# Software Operation

## Quick Print UI



When insert SD card, the toolpath will saved to the SD card.

The file name can not contain non-Latinn characters.

## Print Your First Model

Insert U-Disk to the card reader, open the CreatWare, load 3D model file[1], choose correct filament and option [2], finally click save button[3], you can now finish slice model.

Insert U-Disk to the printer, browse and select the Gcode file you just saved, the printer will automatically start to heating, when the temperature reaches, the printing will start.

# Software Operation

## Full Setting UI

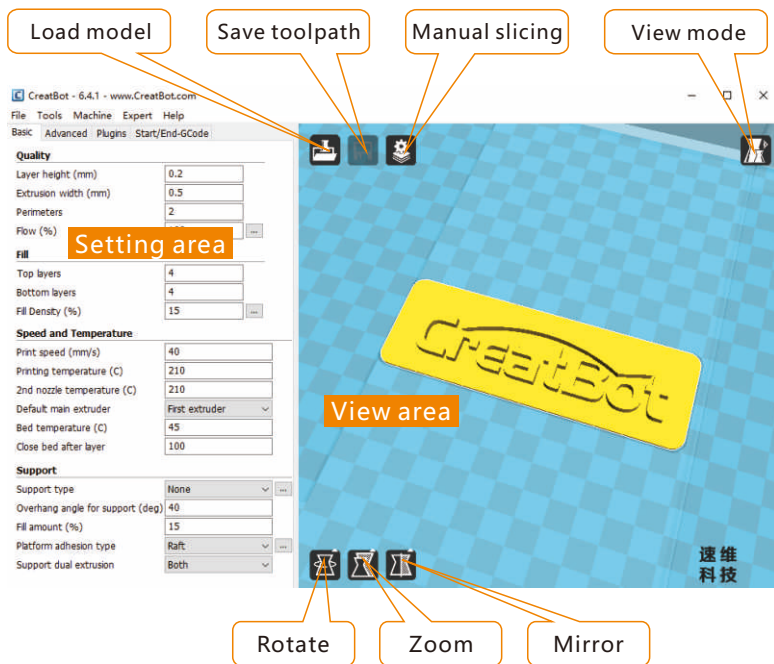

As you can see from the complete UI, the left side of the software is setting area, the right side is view area. The setting area contain "Basic", "Advanced", "Plugins", "Start/End GCode" four tabs. The Basic tab is the most common settings, usually the most frequently used parameters are here. Each parameter has a mouse-over tips, you can set parameters according to the prompt. If you want to restore the default settings, please click on the menu "Tools" -> "Restore Default".



*Tip: Double-click view area can quickly load 3D model file. The view mode and edit icon will appear when you select the 3D mode.*

# Software Operation

## Mouse Operation

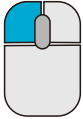

### Left click

Select model, hold and move to change position, double-click to load 3D models.

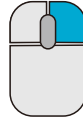

### Right click

Hold and move to rotate the viewpoint around the 3D model.

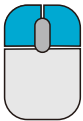

### Left + Right

Hold and move the mouse to zoom.

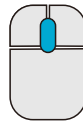

### Scrollwheel

Use the scroll wheel to zoom in or out.

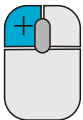

### Left + Shift

Click and drag in rotary model can according to each 1 degree angle.

Shift

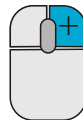

### Right + Shift

Hold and move the mouse to pan the 3D view.

Shift

## Keyboard Shortcut

Ctrl+L Load model/Picture

Ctrl+S Save model as

Delete Remove model

F5 Refresh view area

Ctrl+E Export setting

Ctrl+, Preferences

# Software Operation

## Model Rotate

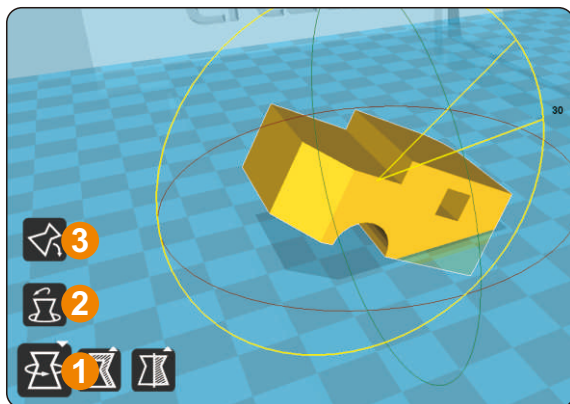

Click on the left corner of the rotate button [1], you can see three ring line around the model, respectively along the X, Y, Z direction. The default rotation angle is 15 degrees, press the Shift key can restrict the rotation angle to 1 degree.

Button [2] is the reset button, can restore rotate status to the default state.

Button [3] is lay flat button, can lay the model flat on the platform automatically.

## Model Scale

Click the left corner of the zoom button [1], you can see a contour line around the model, and shows the current size of the model. You can input the value of the zoom ratio in Scale X / Y / Z , may also directly enter the size you need. Button [4] indicates locking scaling.

Button [2] is zoom reset button, you can restored the model to the default size.

Button [3] for the zoom model size to the maximum print size.

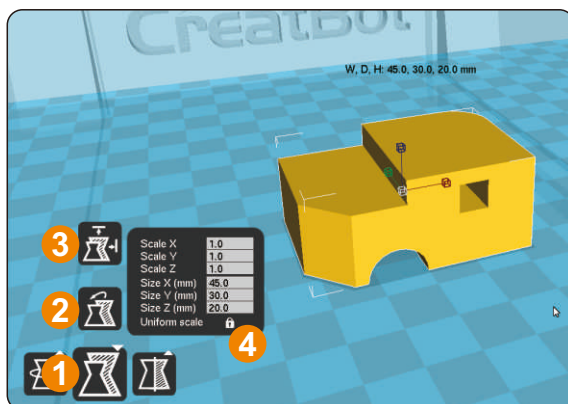



# Software Operation

## Model Mirror

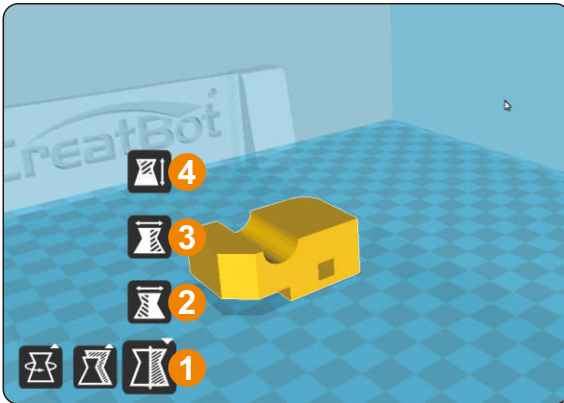

Click the mirror button [1], you can pop up the mirror menu.

Button [2] is a mirror along the X axis.

Button [3] is a mirror along the Y axis.

Button [4] is a mirror along the Z axis.

Note that the mirror transformation is different from the rotation, such as the mirror transformation will lead to a change in the direction of rotation, and the rotation will not change the model.

## View Mode

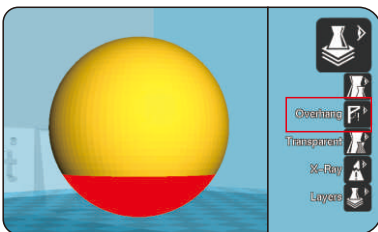

From the overhang view, you can see the suspended part of the model which is shown in red color. By changing the supporting angle can be seen suspended parts size is dynamically changing.

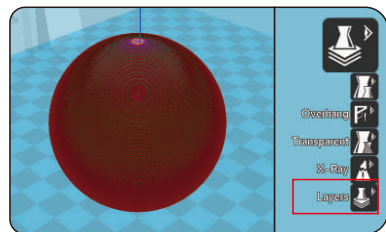

By slice view can easily observe the generated path, you can easily observe the different layers of sliced by slicing altitude indicator, use Ctrl + arrow keys can also be observed layer-by-layer.

# Software Operation

## Right Click on Model

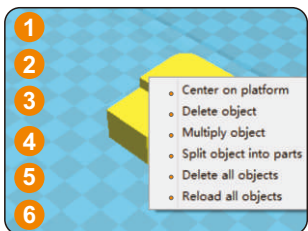

Right-click on the model pop-up shortcut menu, here are more features:

[1] "Centered" make the model back to the center position of the platform. [2] "Delete" to remove the currently selected model. [3] "Multiply" to copy the currently selected model and automatically position, which is useful for printing more than one model at a time. [4] "Split" multi-

component model can be split into its separate components, this process more time-consuming, try to split the model in the modeling software, models splited can be printed individually and then assembled together. [5] "Delete All" to delete all the models loaded. [6] "Reload all" Reload all models, same as F5.

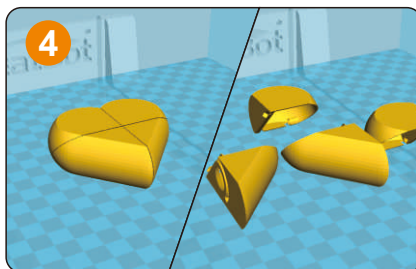
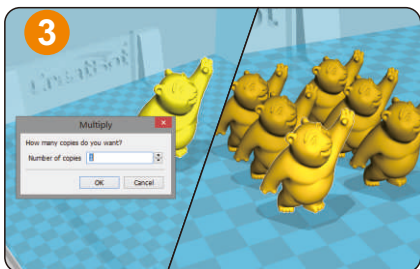

## Toolpath Structure

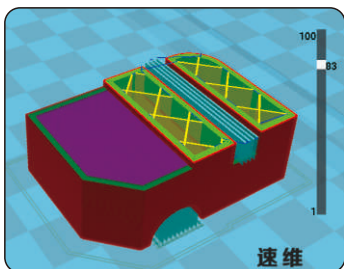

- Red represents "outer shell"
- Yellow represents "infill"
- Green represents "inner shell"
- Blue represents "support"
- Purple represents "bottom and top shell"

Drag layer indicator can browse different level paths, Ctrl + arrow keys to browse layer by layer. 3D printing is the superposition of these different layers and built layer by layer.

# Software Operation

## Basic Setting

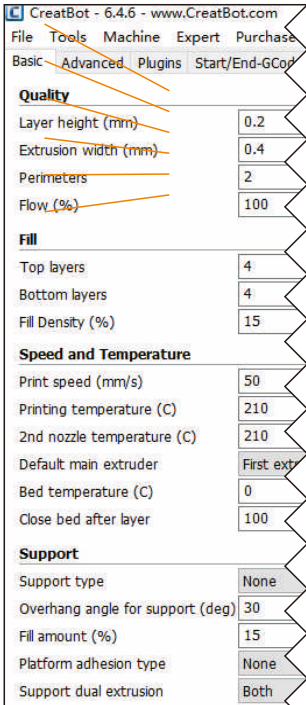

**Layer height:** This is the most important setting to determine the quality of your print, maximum value not exceed 80% of the nozzle diameter.

**Shell thickness:** Refers to the total thickness of the inner and outer walls, the outer wall is only one, the inner wall can be more, set this value to an integer multiple of the diameter of the nozzle.

**Flow:** Refer to the amount of printing material, 100% standard dosage, the more material the model prints more plump.

**top/bottom thickness:** Is the thickness of the upper and lower models, usually a multiple of layer height.

**Fill density:** Control how density filled the insides of your print will be, a value around 20% is usually enough, 0% for hollow.

**Print speed:** Speed at which printing happens. Print speed is affected by many factors, it is recommended to use low speed for complex model, high speed will cause the feed shortage, need improve nozzle temperature to compensate.

**Nozzle temperature:** Is the melting temperature of filament, general use 200 °C for PLA and 240 °C for ABS.

**Bed Temperature:** General use 45 °C for PLA and 70 °C for ABS.

**Default main head:** The default is the first nozzle, can also be set to other nozzles, this can reduce the times of changing filament.

**Support type:** The touching build plate support type is shown in figure [A], everywhere support is shown in figure [B].

**Support angle:** The larger the angle, the more support generate.

**Fill amount:** The larger the fill, the more support generate.

**Platform adhesion type:** The model which is not easy adhesion

on the platform please use Brim, which easy to warped or ABS filament please use Raft.

## Support Type

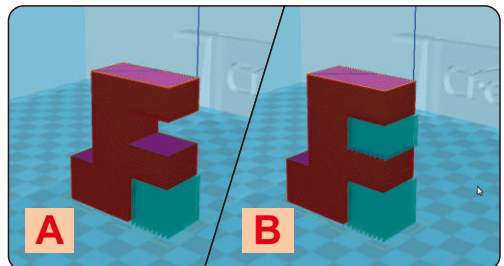

# Software Operation

## Advanced Setting

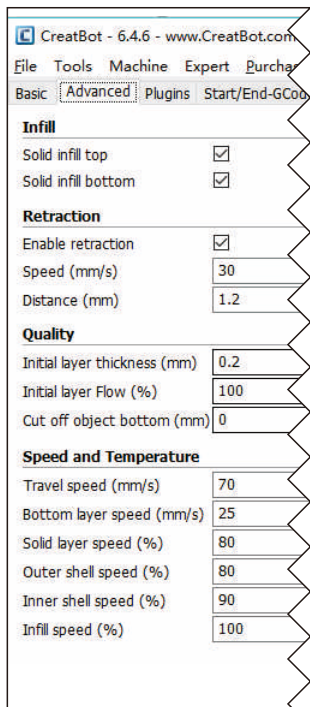

**Solid fill top:** Refers to whether to print the top surface of the model, uncheck will print it with infill method.

**Solid fill bottom:** Same as above, and so on.

**Spiralis print:** Refers to the method of spiral printing the outer wall of the model (single layer), and this feature is very suitable for print glass vase model.

**Enable retraction:** When the nozzle is moving over a non-printed area, withdraw a certain length length filament to prevent overflow.

**Retract speed:** The speed of retraction, too fast can lead motor out of step, too slow increase printing time.

**Retract distance:** The length of the filament when enable retraction.

**First layer thickness:** Height of the first layer of printing, generally greater than 0.15mm.

**First layer flow:** When the set of the first layer is too high, it can be appropriate to increase the extrusion.

**Cut off object bottom:** This can be used for objects that do not have a flat bottom.

**Continue print:** Being "power outages continued" be substituted.

**Travel speed:** The speed when moving over a non-printed area.

**First layer speed:** Slightly slow speed can enhance adhesion

model on the platform.

**Solid layer speed:** The speed is a percentage here, which reference to the global print speed, a combination of different speeds, you can both get a good print quality and a faster print time.

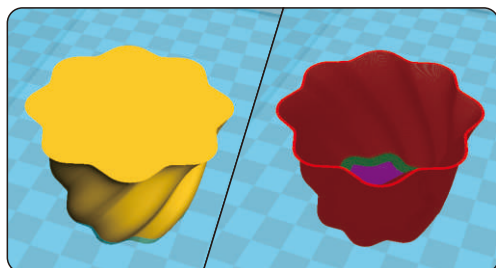

## Spiralise Printing

# Software Operation

## Export Setting

**Nozzle size:** Set the nozzle size.

**Diameter:** Accurate measurement of your filament gives better quality prints.

**Minimum travel:** The minimum distance which can trigger filament retract.

**Minimum extrusion:** The minimal amount of extrusion that needs to be done before retracting.

**Enable combing:** Combing is the act of avoiding holes in the print for the head to travel over.

**Wipe tower:** Is a small tower next to your print where the nozzle wipes itself clean when switching nozzles.

**Dual extrusion switch amount:** Amount of retraction when switching nozzle with dual-extrusion, a value of 15mm seems to generate good results.

**Cooling fan:** The extra cooling fan is essential while printing small model, but when print ABS material, the max fan speed should not more than 50%.

**Skirt:** The skirt is a line drawn around the model at the first layer. This helps to prime your extruder, and to see if the model fits on your platform.

**Brim:** The amount of lines used for a brim, more lines means a larger brim which sticks better.

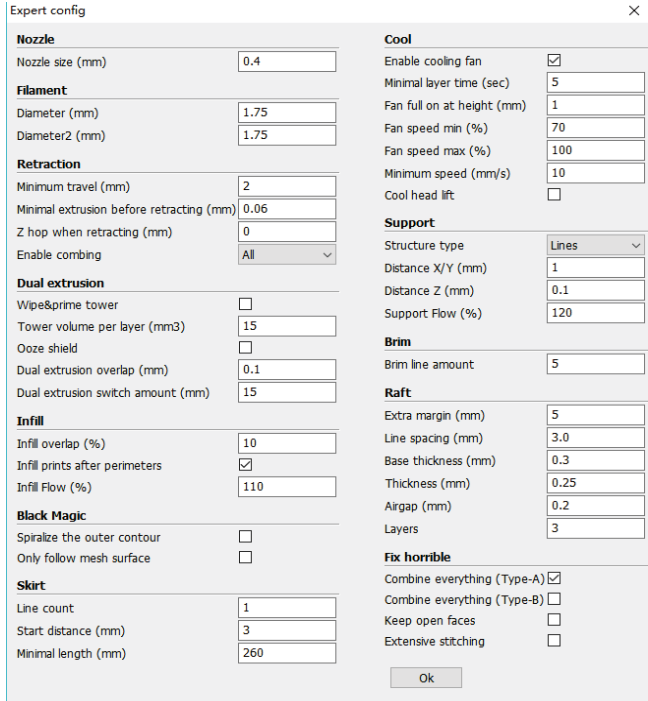

*Notice: Most of the setting have been optimized, If you want restore default configuration, use the menu "Tools" -> "Reset profile to default".*

# Software Operation

## Skirt · Brim · Raft

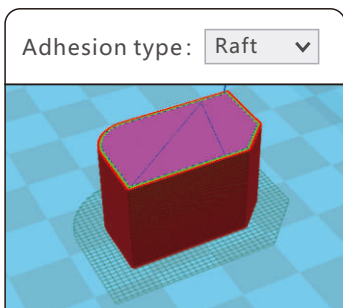
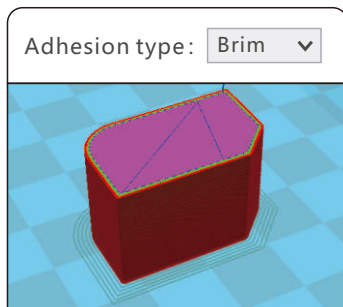
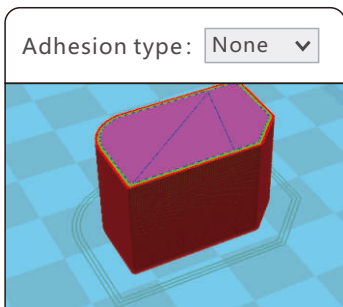

Plugin enable you to easily include your own features, without having to modify the source code or Gcode. In the screen shot above, these can be enabled by clicking on the arrow down button, then you can configure the plugin.



*Notice: Please remove the plugin before you close the software.*

## Plugins

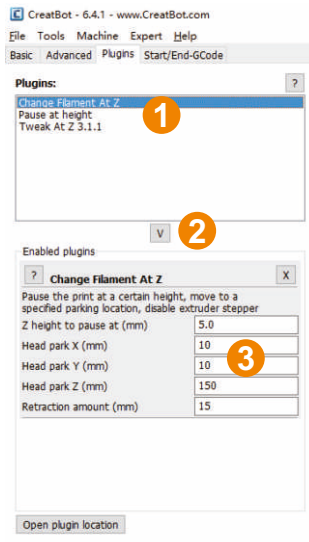

# Software Operation

## Start / End GCode

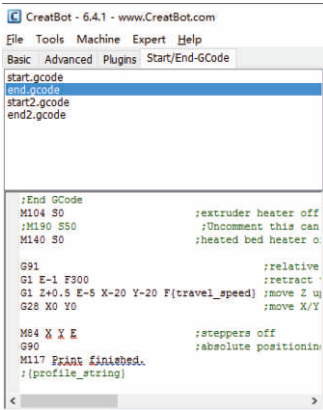

```

CreatBot - 6.4.1 - www.CreatBot.com
File Tools Machine Expert Help
Basic Advanced Plugins Start/End-GCode
start.gcode
end.gcode
start2.gcode
end2.gcode

:End GCode
M104 S0           ;retruder heater off
M190 S50         ;Incomment this can
M140 S0         ;heated bed heater o.

G91              ;relative
G1 E-1 F900     ;retract
G1 Z+0.5 E-5 X-20 Y-20 F[travel_speed] ;move Z up
G28 X0 Y0       ;move X/Y

M84 X Y E       ;steppers off
G90              ;absolute positionin
M117 Print finished.
;[profile_string]
    
```

The start and end code are the startup and end procedure of the print, editing this requires knowledge of GCode.

If you want to set the automatic heating station after printing, you can remove the ";" in the code ";M190 S50".

start.gcode is the start code of single extruder, start2.gcode is the start code of double extruder, and so on.

## Dual Head Printing

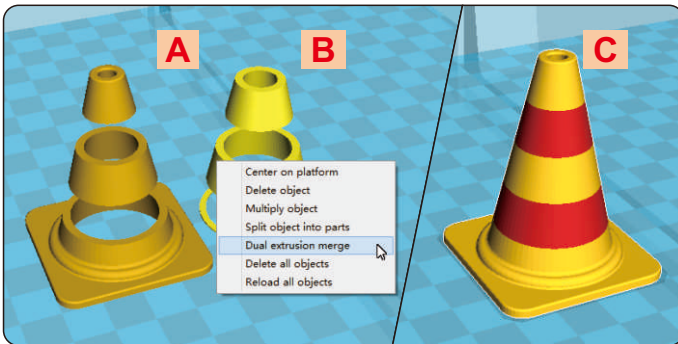

**Step 1:** Load 2 models you want as shown in figure [A] and [B].

**Step 2:** First click [A], then right click on [B], you will get the option: dual extrusion merge, this will merge both models into

one model [C].

**Step 3:** Set parameters like ordinary single color model and save the GCode.



*Tip: The model select first will print by main extruder, the right clicked one by second extruder.*

# Software Operation

## Align Dual Head Horizontal

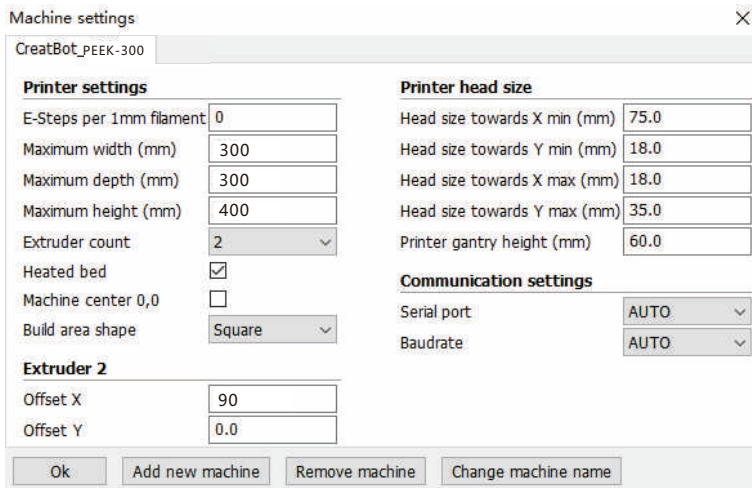

There are alignment problem while printing dual color model, this is because the small difference in multi-nozzle assembly, CreafWare built fine-tuning features.

Click menu "Machine">"Machine settings", default X offset is: 20.0, default Y offset is: 0.0, adjustment method as shown below:

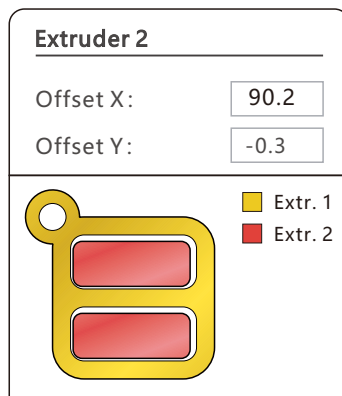
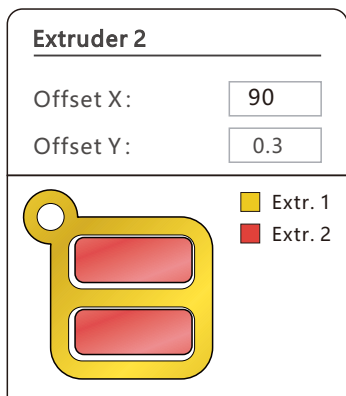



# Software Operation

## Add Multi Type Printer

You can add more than one type of CreatBot to the software, and easily switch between them without re-config all the different machine settings.

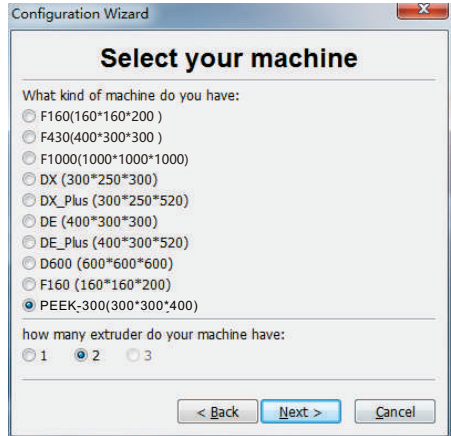
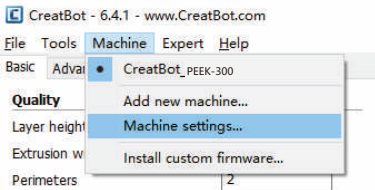

## Print Setting Of Different Filament

	Nozzle temperature	Hot bed	Plantform adhesion type	Fully enclose or not
PLA	190~210°C	None/45°C	None/Raft	Can open
ABS	240~250°C	90°C	Brim/Raft	Enclosed
Nylon	240~270°C	100°C	Brim/Raft	Enclosed
HIPS	230~260°C	100°C	None/Brim	Enclosed
PETG	230~260°C	100°C	None/Brim	Enclosed
Flexible	210~230°C	None/45°C	None	Can open
Wood	190~220°C	None/45°C	None	Can open
PC	230~260°C	100°C	Brim	Enclosed
PEEK	380~430°C	Bed 120°C/Air 70°C	Raft	Enclosed

\* The data is only for reference, different environmental data will be different. F160 and F430 can print PEEK.

# Using skills

## Change Fuse



Open fuse tray



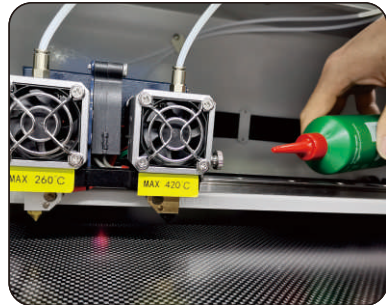
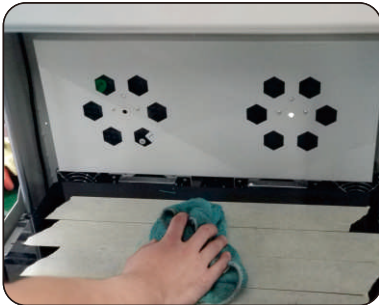

Change new fuse

## Routine Maintenance

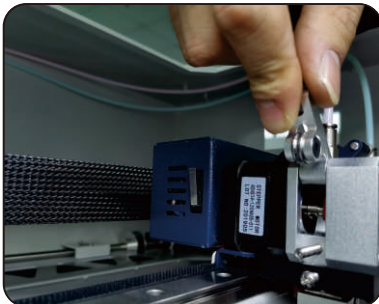

1. Frequent cleaning stains on the rail.
2. Lubricate the four guide rail.
3. Frequent cleaning feeder gear.



 *Notice: Don't add too much lubricating oil.*

# Using skills

## Installation section

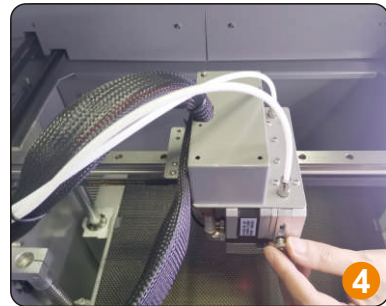
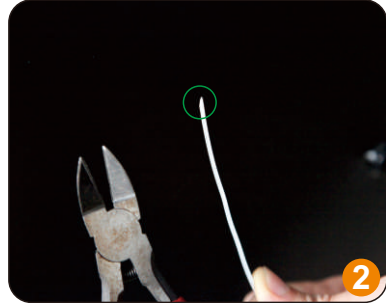
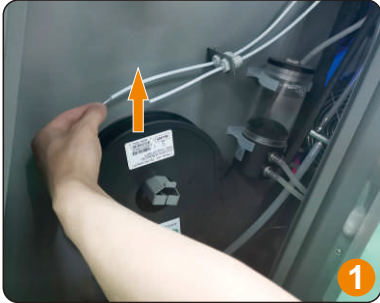

1. Try to use the printed material wheel and rack to feed the filament into the guide pipe, following the direction of consumables bending to prevent the consumables from self-winding.

2. After preheating the hot end, you need to cut the filament end into oblique mouth shape with diagonal pliers, and straightening filament to reduce the bending degree of filament as much as possible.

3. If filament cannot pass through the gear smoothly, you can unscrew the pressing nut, lift the pressing arm, observe and feed into the guide hole.

4. When tightening the nut, starting from the spring force, the pressing nut should be twisted about 8~12 times, not too tight or too loose.

5. Replace the filament, especially for different types of consumables, you need to melt the original filament remnants and extrude them for a period of time before pulling them out quickly. Or choose the menu "Replace filament". If there are residual consumables in the pipe and nozzle, use a small stick as shown in the picture to poke out the filament under the heating state.

## Using skills

1. Better to use printed spool holders. According to curl direction of filament, Get filament through guide tube can prevent winding filament.
2. After preheating nozzle, Sharpen and straighten filament head is necessary. This will get filament through extruder easily.
3. If you can't send filament through nozzle well, remove pressure nut and pressure spring first. Then open pressure arm and clear filament scrap. Sight guide hole and send filament well.
4. Tighten pressure nut. (twist pressure nut 8~12 times after nut touch spring. Neither too loose, nor too tight)
5. Extrude filament for a while and pull out quickly when you change filament. Otherwise, filament may block inside heatbreak. Or choose "Change Filament" on touch screen.  
Use the small stick to poke filament out if there are filament scrap block inside heatbreak or nozzle.

## Software

1. If your machines are equipped with different diameter nozzle (default 0.4mm). You have to setting:
  - Expert-open expert setting... Nozzle size (same to yours)
  - Basic-Quality-Extrusion width (same to yours)
2. Small objects need lower hotend temperature around 190~200°C.  
Large objects better to use Support-Raft. Easy to stick when start printing. Easy to remove when finish printing.

# Frequently Asked Questions

## Hardware Troubleshoot

### 1. Display "MINTEMP" ?

The environment is too low, or temperature sensor is damaged, please keep the room temperature above 0°C.

### 2. Display "MAXTEMP" ?

Temperature of nozzle or bed too high, or temperature sensor is damaged, please keep their temperature in a suitable range.

### 3. USB connection problems ?

Please specify the correct port and baud rate (250000), or change a shorter USB cable.

### 4. Nozzle heats up too slowly ?

Temperature in door is too low, or use a fan duct, or turn up output voltage (24.5v).

### 5. Print head stuck ?

Clean the guide rail and add lubricating oil.

### 6. Print head can not move ?

Stepper motor chipset burned, or belt damaged, or belt wheel screw loose.

### 7. Print head hit the framework ?

Corresponding axis stop limit or circuit fault.

### 8. Unable to power on ?

Power switch is damaged or fuse is burned, and please check whether the power adapter is working properly or power check board is damaged.

## Printing Troubleshoot

### 1. How to set the temperature of the nozzle ?

Different filament temperature is different, general as follows:

PLA temperature 190°C ~210°C, bed 45-60°C

ABS temperature 230°C ~250°C, bed 80-100°C

You must leave enough time for filament heating, so the faster printing speed need the higher temperature, 60mm/s temperature need raise about 10°C. In the same way, larger thickness need higher temperature.

### 2. How to set the temperature of the hot bed ?

The main purpose of the hot bed is to prevent model wrapped, PLA need about 45°C and 70°C for ABS is enough, but due to the environment and filament, we often need to increase the temperature, the highest temperature

# Frequently Asked Questions

## Printing Troubleshoot

not over 120°C, and you can close the bed above 100mm except printing ABS or other high-temperature required filaments.

### **3. The model not stick on the platform ?**

Please paste masking paper or Kapton tape on the platform, or the nozzle is too far away from the platform, or the bottom of the model is not leveled.

### **4. No or less silk coming on the first layer ?**

The distance between nozzle and platform is too small, or the filament has not been sent to the nozzle.

### **5. Why nozzle is not spit silk ?**

The filament is not pressed or too tight, or print temperature is too low, or the filament feeder not working.

### **6. How to prevent model become warped ?**

Increase hot bed temperature or use Kapton, or change platform adhesion type to Raft, or cover the baffle, or reduce indoor ventilation.

### **7. How far from nozzle to platform appropriate ?**

Distance should be 0 in theory, but there is no absolutely flat platform, so the distance should  $\pm 0.1$ mm. Finally, with the actual printing effect as the standard, too close will lead to a silk blocked, too far will cause the model not stick on the platform.

### **8. How to determine whether the temperature is too high ?**

PLA temperature is too high will appear liquefaction, ABS will be the carbide, that will block the nozzle.

### **9. What reasons will causing nozzle blocked ?**

Filament are impurities or print environment dust too much, bad of thermal conductivity between the nozzle and the heating block.

### **10. Model surface is loose with crack ?**

The layer is too high or the printing speed too fast, nozzle temperature too low or filament press nut too loose, or filament is blocked.

### **11. How to print a small model ?**

Multiple the model, and print them at a time.

### **12. Dual color model not aligned ?**

Adjust offset of second nozzle in machine settings.





### **13. Dual color model color interference ?**

Align two nozzle in vertical direction

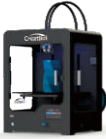

### **14. There is too much silk drag on the model ?**

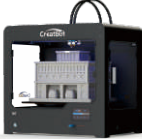
Please enable filament retraction, and specified proper retract speed, and distance, the retract distance should not less than 2mm, and the speed not less than 30mm/s.

## Specifications



				
Model	DX	DX Plus	DE	DE Plus
Build volume	300*250*300	300*250*520	400*300*300	400*300*520
Nozzles	Dual/Tris			
Diameter	0.4mm(0.3/0.6/0.8/1.0mm can be customized)			
Temperature	350°C			
Nozzles Type	print head/new print head			
Hot bed	100°C (can be closed after certain layers)			
Min. Layer	0.04mm			
Accuracy	X、Y、Z axis 0.01mm			
Print Speed	120mm/s (inner/outer, top/bottom, fill, first layer speed can be set separately)			
Travel Speed	200mm/s			
Materials	ABS,PLA,TPU,PETG,HIPS,PVA, PA,PC,Carbon Fibre,etc			
Fila. Diameter	3.0mm (1.75mm optional)			
Keypad	Yes (nine key)			
Auto Turnoff	Yes (pwr manager + relay)			
Continue Play	Yes (Power outage, lower plate and save data)			
Fila. Check	Yes (pause printing when filament finish, and lower platform)			
Adju. Head	Yes (height-adjustable-nozzles)			
OS	Windows, Linux, Mac OS, OSX			
Languages	Chinese, English multi-language			
Software	CreatWare Multi-language , Simplify3d			
File Format	STL, OBJ, GCode, Amf			
Chipset	Atmega 2560-16AU (AVR 8 Bit 16MHz, 256KB Flash)			
Display	128*64 monochrome multi-language (support color TFT)			
Pwr Supply	110/220V 360W		110/220V 700W	
Dimension	420*380*570	420*380*790	590*430*570	590*430*790
Weight	35 Kg	40Kg	45Kg	55Kg

## Specifications

			
Model	F160	F430	D600
Build volume	160*160*200	400*300*300	600*600*600
Nozzles	Single	Single/Dual	
Diameter	0.4mm(0.3/0.6/0.8/1.0mm can be customized)		
Temperature	400 °C		350 °C
Nozzles Type	Direct drive		
Hot bed	140 °C	Bed 120 °C / Air 70 °C	100 °C
Min. Layer	0.04mm		
Accuracy	X、Y、Z axis 0.01mm		
Print Speed	120mm/s (inner/outer, top/bottom, fill, first layer speed can be set separately)		
Travel Speed	200mm/s		
Materials	ABS,PLA,TPU,PETG,HIPS,PVA, PA,PC,Carbon Fibre,PEEK,etc		
Fila. Diameter	1.75mm		3.0mm
Motion Structures	Optic axis		Rectilinear orbit
Auto Turnoff	Yes (pwr manager + relay)		
Continue Play	Yes (Power outage, lower plate and save data)		
Fila. Check	Yes (pause printing when filament finish, and lower platform)		
Adju. Head	Yes (height-adjustable-nozzles)		
OS	Windows, Linux, Mac OS, OSX		
Languages	Chinese, English multi-language		
Software	CreatWare Muti-language		
File Format	STL, OBJ, GCode, Amf		
Printing Field	Full closed covering		
Display	4.3 inches color touch screen		
Pwr Supply	110/220V 180W	110/220V 1300W	110/220V 1000W
Dimension	280*280*470mm	660*470*560mm	910*840*1100mm
Weight	22Kg	60Kg	170Kg



## Specifications

		
Model	PEEK-300	F1000
Build volume	300*300*400mm	1000*1000*1000mm
Nozzles	Double	
Diameter	0.4mm(0.3/0.6/0.8/1.0mm optional)	1.0 mm (0.4~1.5 mm)
Temperature	Max 500°C	Max 420°C
Hot bed	Max 200 °C	Max 100°C
Min. Layer	0.05mm	0.05mm
Accuracy	X.Y0.011mm;Z 0.025	X.Y0.011mm;Z 0.025
Print Speed	10-150 mm/s	10-120 mm/s
Materials	ABS,PLA,Carbon Fiber,PETG,Nylon,PC,etc.	
Fila. Diameter	1.75 mm	
Auto Turnoff	Yes (pwr manager + relay)	
Continue Play	Yes (Power outage, lower plate and save data)	
Fila. Check	Yes (pause printing when filament finish, and lower platform)	
Adju. Head	Yes (height-adjustable-nozzles)	
OS	Windows, Linux, Mac OS, OSX	
Languages	Chinese, English	
Software	CreatWare Muti-language	
File Format	STL, OBJ, GCode, Amf	
Chipset	Atmega 2560-16AU (AVR 8 Bit 16MHz , 256KB Flash)	
Display	4.3 inches color touch screen	9.7 inches color touch screen
Pwr Supply	110-220v 3000W	220~240 V, 50~60 Hz;4000W
Dimension	650*600*750 mm	1910*1510*2205mm
Weight	100 kg	640 kg



Quality · Experience · Service